

RENCO INC.

SERIES REN23, REN28 & REN30-300

ERGONOMICALLY DESIGNED

PNEUMATIC

TWO-HAND NO-TIE-DOWN CONTROLS

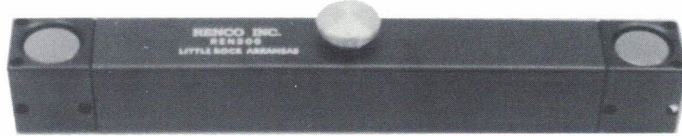

SERIES
REN300
PAGE 4.

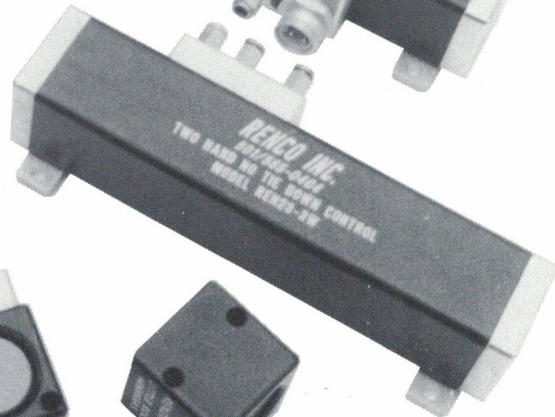
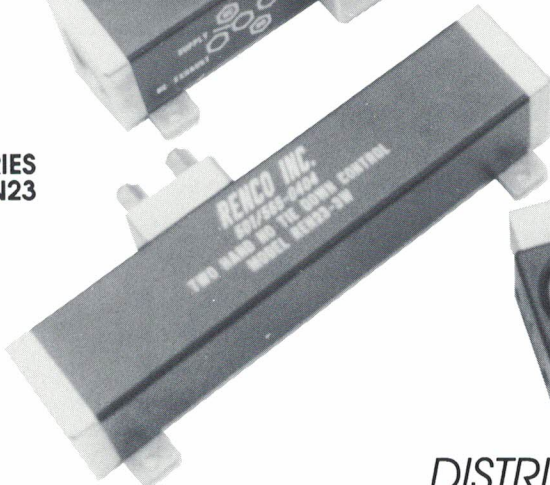
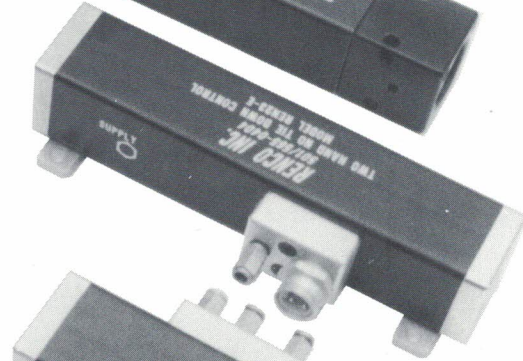
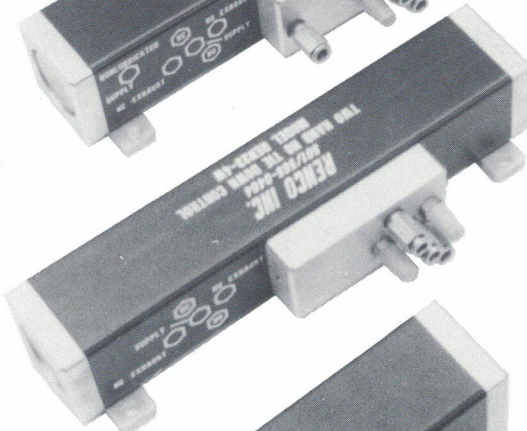
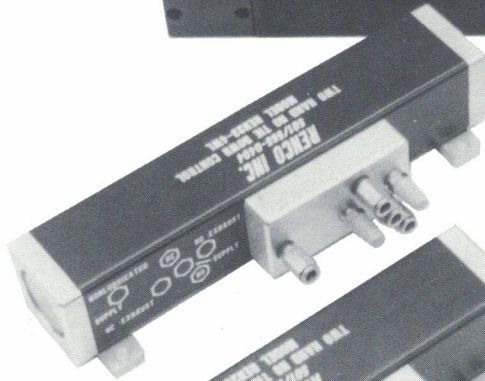

SERIES
REN23

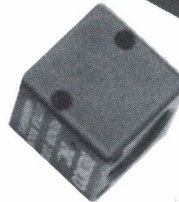
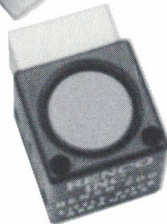

DISTRIBUTED BY:

SERIES REN28 PAGE 3.

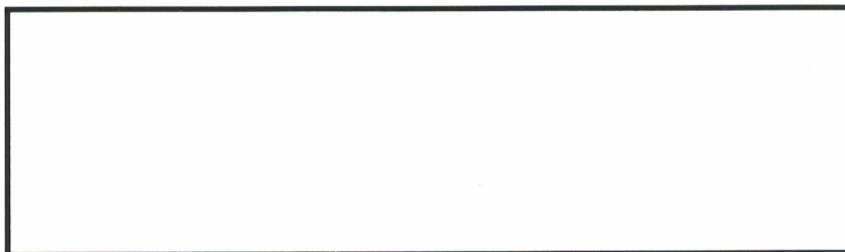

MADE IN THE U.S.A.

SERIES REN23

**GIVES A MAINTAINED OUTPUT SIGNAL WHEN BOTH
BUTTONS ARE PRESSED WITHIN .3 SECONDS AND HELD**

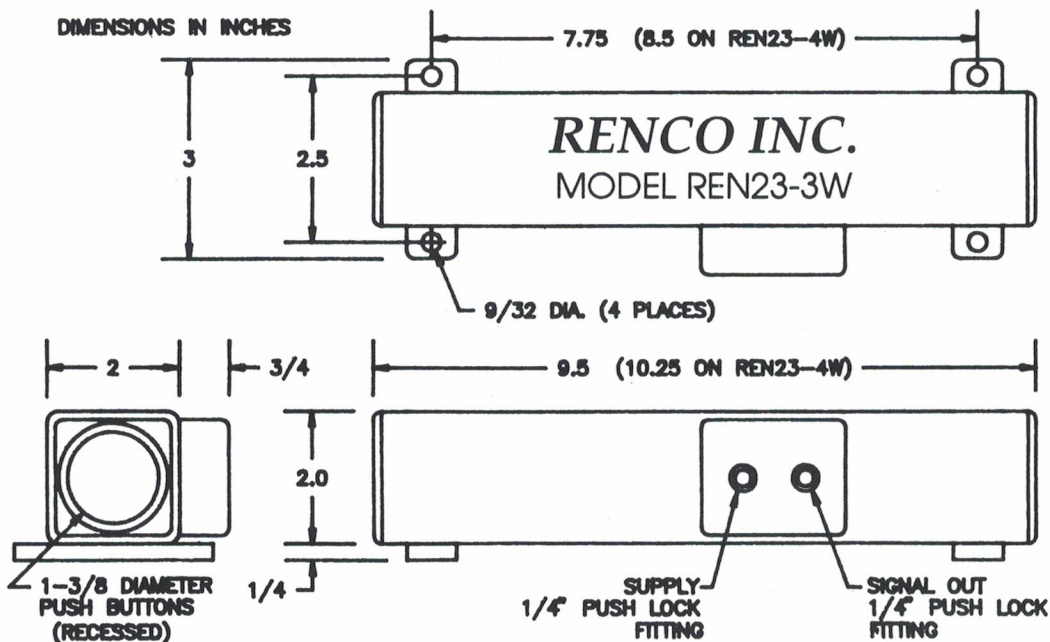

- ▶ **COMPACT DESIGN WITH 1-3/8" DIAMETER PUSH BUTTONS (RECESSED) .**
- ▶ **LIGHT ACTUATION PRESSURE (5 OUNCES).**
- ▶ **1/4" PUSH LOCK FITTINGS INCLUDED.**
- ▶ **ROUNDED EDGES, NO SHARP EDGES OR CORNERS TO INJURE OPERATOR.**
- ▶ **QUICK AND SIMPLE INSTALLATION, BOLT THE CONTROL DOWN AND PLUG IN.**

THREE MODELS AVAILABLE

REN23-3W	INTERNAL 3-WAY VALVE.
REN23-4W	INTERNAL 4-WAY VALVE WITH 1.1 CV FACTOR.
REN23-4WL	REN23-4W WITH SEPARATE CONNECTION FOR LOGIC MODULE. VERY HEAVY LUBRICATION MAY BE INSERTED IN MAIN SUPPLY.

OPTIONS AVAILABLE ON THE REN23-3W.

- C CANCELABLE OUTPUT. AN INPUT FROM A PRESSURE OR LIMIT VALVE WILL CANCEL THE OUTPUT.
- P .4 SECOND PULSED OUTPUT.
- B BOTTOM CONNECTIONS. CONNECTION ON BOTTOM OF MANIFOLD.
- EPB (EXTRA PUSH BUTTON) A CENTER MOUNTED N/C 3-WAY VALVE WITH BUTTON ON TOP (GUARDED) HAS A SEPARATE OUTPUT MARKED EPB.

OPTIONS AVAILABLE ON ALL REN23 SERIES.

- 532 5/32 (4 MM) PUSH LOCK FITTINGS. (NO CHARGE)
- G BUTTON GUARDS. GUARDS THAT SURROUND THE BUTTONS AND EXTEND 1/2",

ALWAYS USE DRY, NONLUBRICATED AIR.

WARNING: ALL RENCO CONTROLS ARE DESIGNED TO OPERATE PNEUMATIC VALVES AND CYLINDERS. THEY ARE NOT TO BE USED WITH FLYWHEEL PRESSES, BRAKE PRESSES OR SIMILAR DEVICES. IT IS THE BUYERS RESPONSIBILITY TO DETERMINE THE USE AND MOUNTING LOCATION OF THIS DEVICE. THIS EQUIPMENT PERFORMS THE FUNCTION OF A TWO HAND NO TIE DOWN CONTROL ONLY, ALL OTHER PRESCRIBED SAFETY DEVICES MUST BE USED WITH THIS EQUIPMENT. IT IS THE BUYERS RESPONSIBILITY TO DETERMINE THE PROPER APPLICATION, LOCATION AND USE OF THIS EQUIPMENT.

RENCO, INC.

6719 ALCOA ROAD, BENTON, ARKANSAS 72015 USA 501/565-0404 FAX 501/565-4796

**ONE PALM BUTTON GIVES A MAINTAINED OUTPUT SIGNAL
WHEN BOTH BUTTONS ARE PRESSED WITHIN .3 SECONDS AND HELD.**

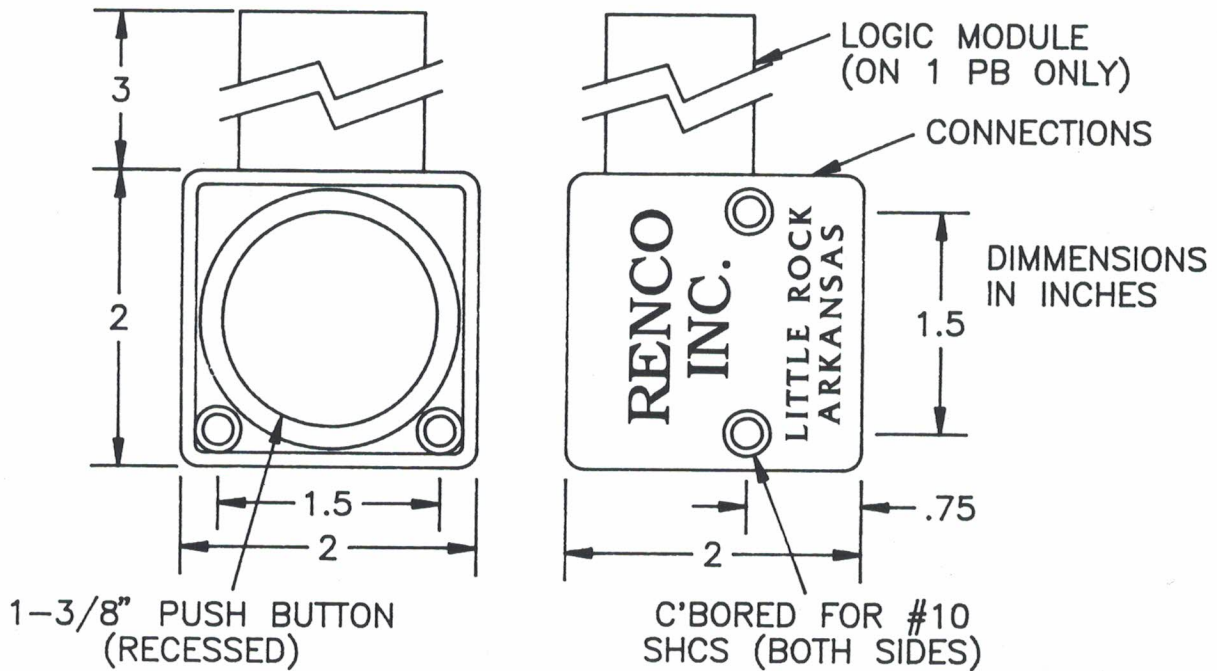

- ▶ **MOUNTS VERTICALLY OR HORIZONTALLY, NO MOUNTING BRACKET REQUIRED.**
- ▶ **LIGHT ACTUATION PRESSURE (5 OUNCES).**
- ▶ **MOUNTING SCREWS INCLUDED (10-32).**
- ▶ **1/8" NPT CONNECTIONS. 5/32 (4MM) PUSH LOCK FITTINGS OPTIONAL.**
- ▶ **COMPACT DESIGN WITH 1-3/8" PUSH BUTTONS (RECESSED 1/4").**
- ▶ **ROUNDED EDGES, NO SHARP EDGES OR CORNERS TO INJURE OPERATOR.**

THE SERIES REN28 IS TWO SEPARATE PALM BUTTONS THAT USE OUR LIGHT TOUCH VALVES, ATTACHED TO ONE PALM BUTTON IS OUR LOGIC MODULE. THEY ARE EASY TO INSTALL, MOUNT SECURELY THEN CONNECT A SUPPLY LINE TO EACH PALM BUTTON THEN CONNECT THE PALM BUTTONS WITH ONE AIR LINE. ONE PALM BUTTON GIVES A MAINTAINED OUTPUT SIGNAL WHEN BOTH PALM BUTTONS ARE PRESSED WITHIN .3 SECONDS.

THE PART # IS REN28-SET FOR BOTH PALM BUTTONS. THE PART # FOR THE PALM BUTTON WITHOUT THE LOGIC MODULE, WHICH MAY BE USED AS A 3-WAY PNEUMATIC PUSH BUTTON, IS REN28-100.

OPTIONS AVAILABLE ON THE REN28-SET.

- C CANCELABLE OUTPUT. AN INPUT FROM A PRESSURE OR LIMIT VALVE WILL CANCEL THE OUTPUT.
- P .4 SECOND PULSED OUTPUT.
- PA .1-30 SECONDS ADJUSTABLE PULSED OUTPUT.
- 532 5/32 (4 MM) PUSH LOCK FITTINGS.
- G BUTTON GUARDS. GUARDS THAT SURROUND THE BUTTONS AND EXTEND 1/2", STANDATD RECESS IS 1/4".

ALWAYS USE DRY, NONLUBRICATED AIR.

RENCO, INC.

6719 ALCOA ROAD, BENTON, ARKANSAS 72219 USA 501/565-0404 FAX 501/565-4796

SERIES REN300

**GIVES A MAINTAINED OUTPUT SIGNAL WHEN BOTH
BUTTONS ARE PRESSED WITHIN .3 SECONDS AND HELD.**

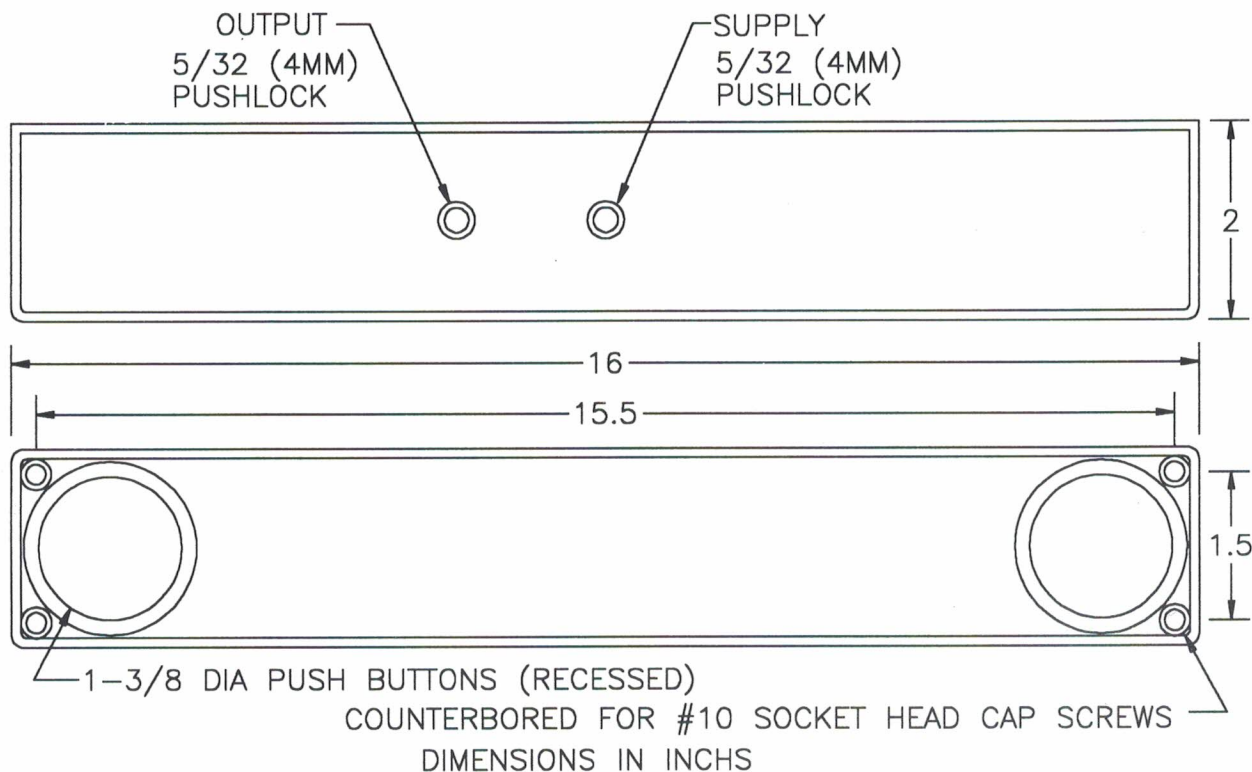

- ▶ **COMPACT DESIGN WITH 1-3/8" DIAMETER PUSH BUTTONS (RECESSED 1/4") ON TOP.**
- ▶ **LIGHT ACTUATION PRESSURE (5 OUNCES).**
- ▶ **MOUNTING SCREWS INCLUDED (10-32).**
- ▶ **5/32 (4MM) PUSH LOCK CONNECTIONS.**
- ▶ **ROUNDED EDGES, NO SHARP EDGES OR CORNERS TO INJURE OPERATOR.**
- ▶ **QUICK AND SIMPLE INSTALLATION, BOLT THE CONTROL DOWN AND PLUG YOUR TUBING INTO THE 5/32" (4MM) PUSH LOCK CONNECTIONS.**

THE SERIES REN300 FEATURES TOP PALM BUTTONS, THAT USE OUR LIGHT TOUCH VALVES, THIS ALLOWS THE OPERATOR TO KEEP HIS PALMS FACING DOWN.

OPTIONS AVAILABLE ON THE REN300.

- C CANCELABLE OUTPUT. AN INPUT FROM A PRESSURE OR LIMIT VALVE WILL CANCEL THE OUTPUT.
- P .4 SECOND PULSED OUTPUT.
- PA .1-30 SECONDS ADJUSTABLE PULSED OUTPUT.
- T100 FRONT MOUNTED 1.1 CV 4-WAY VALVE WITH 1/4" PUSHLOCK FITTINGS AND MUFFLERS. BUTTON GUARDS. GUARDS THAT SURROUND THE BUTTONS AND EXTEND 1/2", THE STANDARD RECESS IS 1/4".
- G

ALWAYS USE DRY, NONLUBRICATED AIR.

RENCO, INC.